

HX3.7 MC (SAM5504) Version 2

Added C81 close to U18
 Added C82 close to U14
 Changed value of C67 to 2µ2
 Changed value of R68 to 10k

Änderung: BOOT0
 war auf Prototyp an Vcc 3.3V
 R57 um 90 grad drehen und
 an Masse legen!

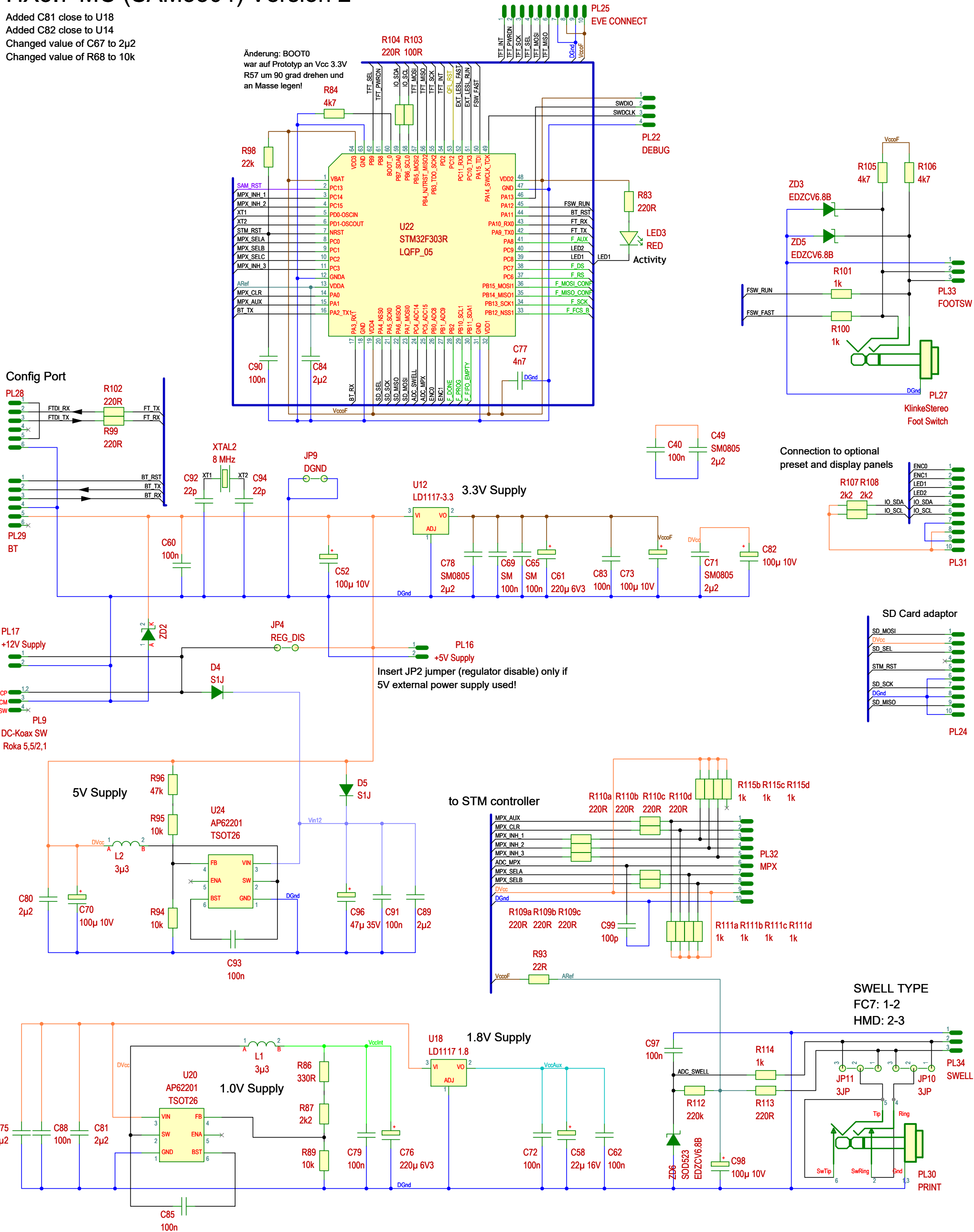

Config Port

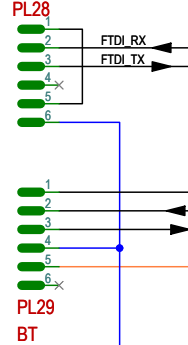

+12V Supply

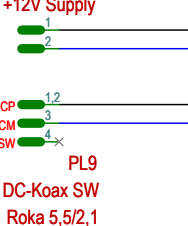

5V Supply

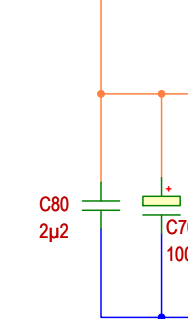

1.0V Supply

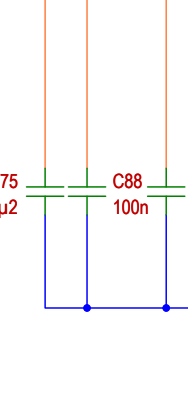

to STM controller

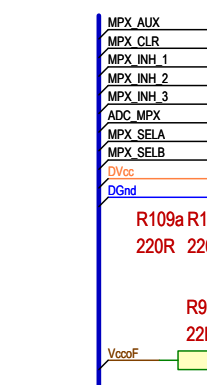

Connection to optional preset and display panels

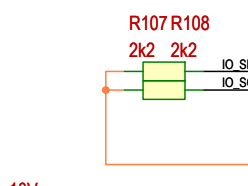

SD Card adaptor

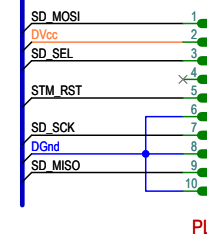

SWELL TYPE

